

# Intercom Server S6

High performance Intercom Server for rack mounting



Up to 448  
subscribers

VirtuoSIS  
on board

VoIP<sup>®</sup> and  
SIP

Easy to  
expand

Backwards  
compatible

16kHz  
eHD Voice

## The ultimate Intercom appliance

In 2013, Commend introduced the worldwide first 100% software-based Intercom Server. However, VirtuoSIS was only available for virtualised IT environments so far. The Intercom Server S6 brings all VirtuoSIS features into common server rooms as well.

The cost-efficient and compact total package of hardware and software can be extended flexibly. Therefore, no extra hardware is needed – it is only necessary to activate the desired licences.

A strong software provides all VirtuoSIS benefits. This means that the S6 combines reliability, crystal-clear intelligibility, easy maintenance as well as low costs. And, of course, the S6 is fully compatible to earlier Commend systems – such as Intercom servers or stations.

## Features and highlights

- Compact Intercom Server including VirtuoSIS Professional
- Redundant hot-plug power supply unit available separately
- Easy to expand using the desired licences
- Backwards compatible to expand existing Commend systems
- High energy efficient
- Supports IP-based, digital and analogue Intercom stations as well as Commend SIP stations and third-party SIP phones
- VoIP connectivity to PSTN via SIP gateways
- IPv4 for VoIP<sup>®</sup>
- IPv4 and IPv6 for SIP clients/trunk connections (audio and video)
- Supports all Intercom functions and feature levels
- Networkable with all IP Intercom Servers via LAN or WAN
- Networkable with the Intercom Servers S3, GE 800 and VirtuoSIS via NET
- IP interfaces: ICX over IPv4/IPv6, RTP, SIP over TLS and (S)RTP as well as VoIP<sup>®</sup>
- Central configuration via the configuration software CCT 800
- Supports Commend Solution Apps, e.g. ComPLC
- Requires no key subscribers
- Optimised for rack mounting

## Examples of use

Below, typical application scenarios for the S6 are shown. These applications can also be combined individually.

### Expansion of an existing system

The S6 is integrated as additional server in an existing system in order to use up to 448 additional IP or SIP subscribers.

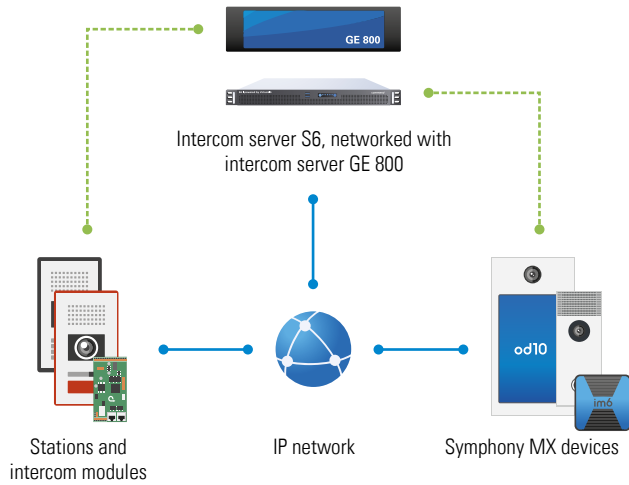

### SIP solution

The S6 is used for up to 448 SIP subscribers. A cost-efficient start is already possible with the licence L-SIS-SIP-8A.

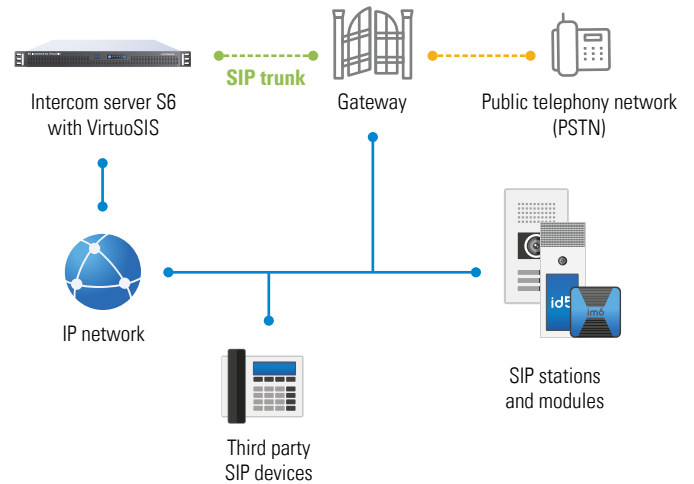

### VoIP® solution

The S6 is used for up to 448 IP subscribers.

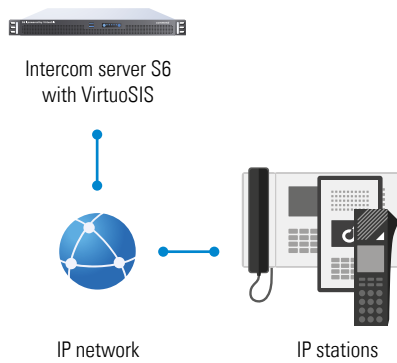

### Mixed solution

The S6 is used as a part of a mixed system with VoIP® as well as SIP subscribers and SIP trunks.

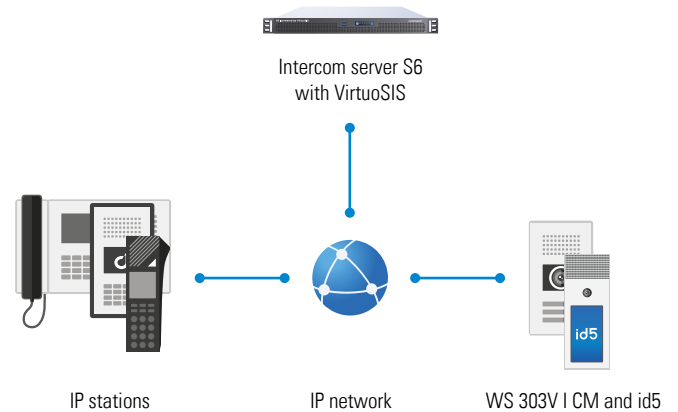

## More examples of use

Below, typical application scenarios for the S6 are shown. These applications can also be combined individually.

### Cloud integration with Symphony Bridge

The on-prem Intercom server S6 in combination with Symphony Bridge provides versatile networking options with Symphony Cloud, including a number of system functions.

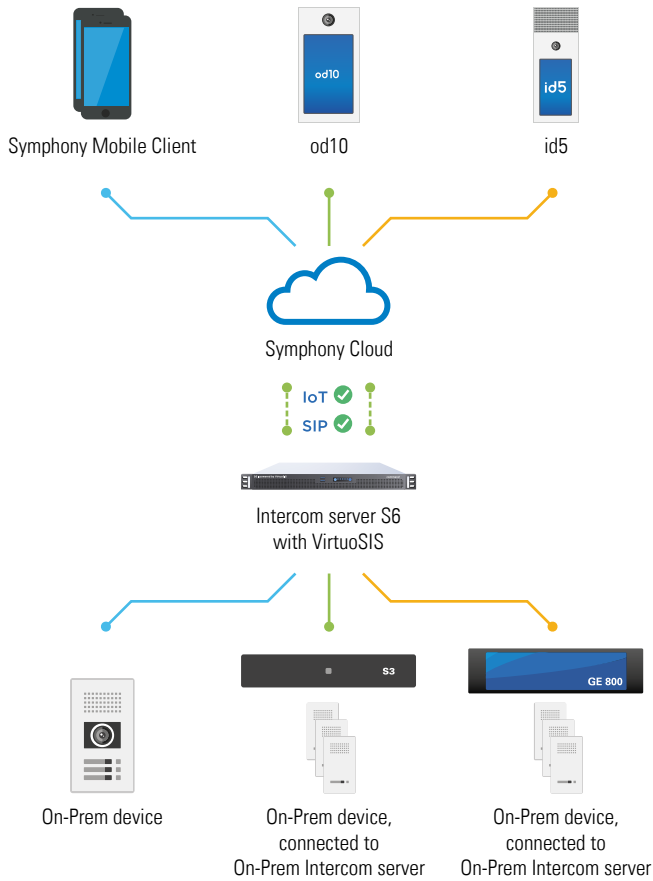

### Latest Comend Solution Apps

The S6 is integrated as additional server in an existing system in order to use the latest Comend Solution Apps. For this application, the interfaces ICX, KNX and MODBUS are available.

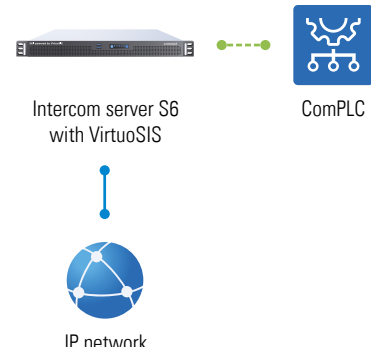

### Networked server infrastructure

The S6 can be networked with other servers via LAN, WAN or NET.

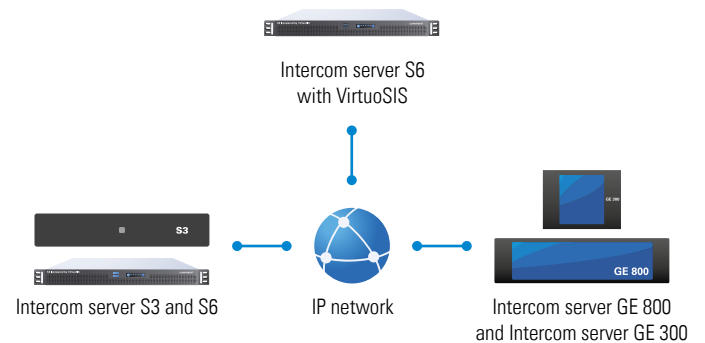

## Commend Intercom platform

### Voice communication with 16 kHz sound experience

Commend's 16 kHz audio standard transmits voice communication, emergency calls and especially music with previously (literally) unheard-of clarity. At the same time, the IP Intercom Servers double as PA servers to enable the combination of public address and Intercom on a single platform.

### Intercom solutions by Commend

Data networks enable the transmission of all kinds of data. For Intercom transmissions, Commend has developed a specific technology: IoIP®, short for Intercom over IP. As a logical further development of the Voice over IP standard, IoIP® provides better speech quality and higher data security and serves as the Commend standard for the professional integration of Intercom stations, control and display functions, networking of Intercom Servers, and especially for security and communication solutions.

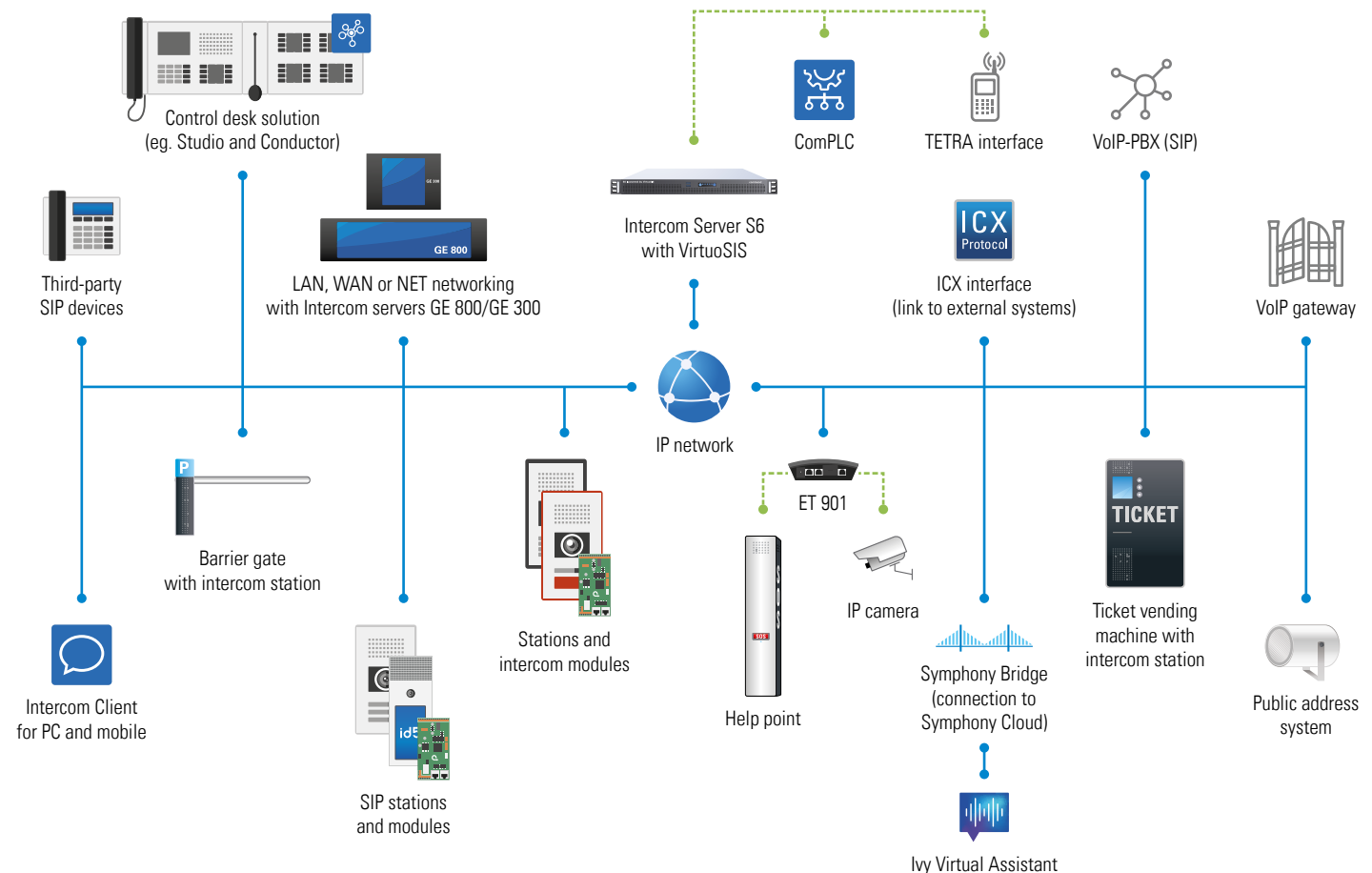

### Ready for connection of

- IP Intercom stations
- Commend SIP stations and third-party SIP phones
- 2-wire Intercom stations (with IP Intercom box ET 901-D)
- 4-wire Intercom stations (with IP Intercom box ET 901-A)

### 100% flexible, 100% compatible

VirtuoSIS adapts easily and flexibly to your project requirements while remaining fully compatible with previous system generations. The server supports all IP-based, digital and analogue Intercom stations by Commend; third-party systems can be integrated easily via Intercom eXchange protocol (ICX).

### Integration of Commend Solution Apps

Thanks to direct integration of any Commend Solution App into VirtuoSIS, no further hardware or software is needed. That's why it is easy to use third-party systems e.g. TETRA by simply licensing the appropriate interface on the Intercom Server.

### Highlights from more than 150 features

- Control desk functions
- Functional monitoring of microphone, loudspeaker and Intercom station lines
- Control functions (video, doors and gates etc.)
- Pre-recorded voice messages for customised announcements (waiting, information, alarm messages etc.)
- Audio monitoring for automated call triggering, e.g. at a scream or shout
- Audio recording interfaces
- All Calls and group calls with automated response function
- Conference calls with any number of subscribers
- Call forwarding
- Integration of third-party systems (OPC, TETRA etc.)
- Seamless VoIP integration via SIP
- And many more ...

## Increased possibilities through SIP

SIP subscribers can be integrated – first and foremost the versatile and multi-functional Commend SIP series – directly into the Intercom network. This makes it possible for a vast range of VoIP devices to communicate with each other over the Intercom network and to fulfill basic Intercom features.

### What is SIP-C?

Via the virtual SIP-C card, it is possible to use SIP clients (SIP-C) like third-party SIP phones and Commend SIP stations into VirtuoSIS directly. For this, only a simple IP network connection is necessary.

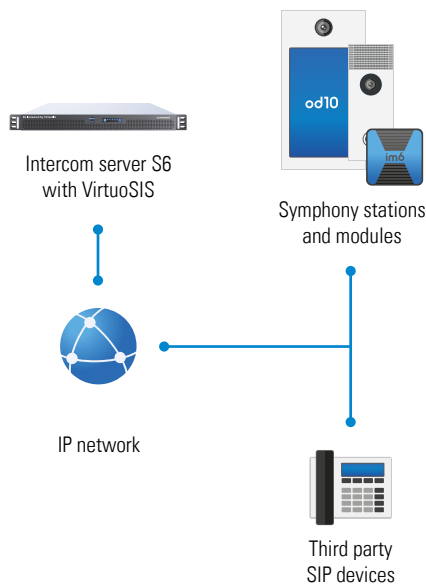

### What is SIP-T?

Using a SIP trunk (SIP-T), VirtuoSIS can be connected to one or several third-party SIP servers. As soon as a SIP-T connection is established, there is an huge mutual benefit: all servers are able to use numerous of features and functions of the other one.

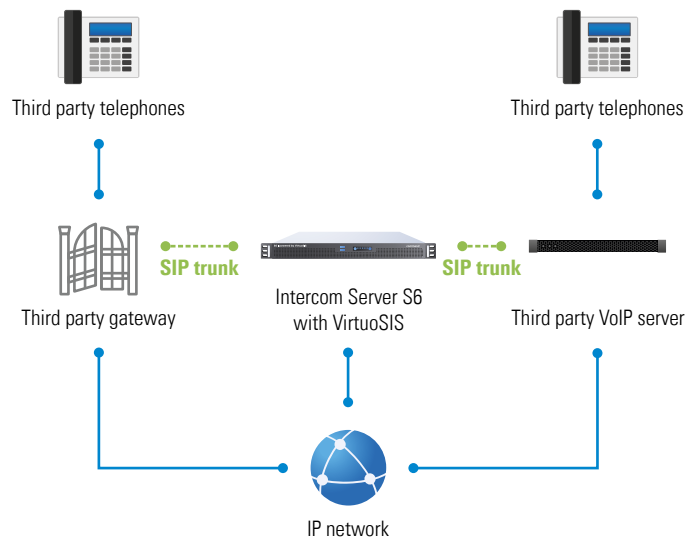

### Highlights SIP-C features

- Line monitoring for SIP-T and SIP-C subscribers
- Triggering call requests, optionally with calm down message and/or with assigned video camera
- Door station with a contact triggered via DTMF
- Listening to radio channels
- Receiving All Calls, group calls and door ringing calls
- Participant radio conference
- Control desk function
- Receiving call requests and corresponding ICX messages
- OpenDuplex® conferences
- Protocols used for SIP-C: UDP, TCP and TLS
- Supported video codec: H.264/MPEG-4 AVC

### Start smart with feature level A subscribers

- Ideal for small-sized systems
- Basic Intercom functions: privacy call, conversation, group ringing to group 0 and door opener via DTMF after-dialling
- Expandable to feature level B with the upgrade licence L-UG-8B or to feature level D with the upgrade licence L-UG-1D

### Highlights SIP-T features

- Each channel can be assigned to a separate trunk
- Up to 8 SIP trunks per card
- The trunk automatically selects one of the free assignment channels
- Line monitoring
- Configuration of dial-prefixes, pre-dialling and code numbers for easy call numbers within the system
- Call history with up to 20 entries (0T)
- Basic Intercom functions (e.g. calls)
- Executive-secretary transfer chain
- Initiator conference
- Alarm receiver
- Control desk function
- Auto dialler mode
- Audio mixing for speech recording
- PA function (for phone call by direct outward dialling)
- Radio feed-in (4T, 6T)
- Protocols used for SIP-T: UDP, TCP and TLS
- Supported video codec: H.264/MPEG-4 AVC

# Intercom Server S6

## Technical specifications



### Technical data

<b>Registered subscribers:</b>	IP/SIP: max. 448
<b>Parallel calls:</b>	lolP conversations (audio): max. 32 per instance SIP conversations (audio): max. 32 per instance  SIP conversations (audio): max. 64 per master SIP conversations (audio/video): max. 64 per master  A single conversation may use one or more channels. For further information on the concurrent use of SIP audio channels, see manual <b>"Intercom Server Configuration"</b> .
<b>Concurrent channels in use:</b>	SIP channels (audio): max. 128 SIP channels (audio/video): max. 128
<b>VirtuoSIS Instances:</b>	1 VirtuoSIS Master mit max. 4 VirtuoSIS Instanzen
<b>Compliance:</b>	EN 55032 Class B, EN 55035, EN 61000-6-2, EN 61000-6-3, FCC Part 15 Class B, ICES-003 Class B, IEC/EN 62368-1
<b>Operating system:</b>	Linux Debian 12 (64 bit)
<b>Intercom Server software:</b>	VirtuoSIS (pre-installed)
<b>Network interfaces:</b>	up to 2
<b>Data rate:</b>	up to 1 Gbps per Ethernet port
<b>Rated current:</b>	max. 0.14 A (240 V)/max. 0.34 A (100 V)
<b>Power supply:</b>	max. 300 W, min. 88 % efficiency (80Plus Gold) 100 – 240 V (50/60 Hz)
<b>Power consumption:</b>	with a single power supply: idle: 22 – 23 W full load: 34 – 37 W  with redundant power supply: idle: 25 – 26 W full load: 42 – 44 W
<b>Operating temperature range:</b>	0 °C to +40 °C (+32 °F to +104 °F)
<b>Storage temperature range:</b>	-25 °C to +60 °C (-13 °F to +140 °F)
<b>Relative humidity:</b>	5 % to 85 %, not condensing
<b>Installation:</b>	Installation in a server rack (1 RU to 19"), rack mount kit included in extent of supply
<b>Dimensions (W x H x D):</b>	427 x 44.4 x 381 mm (16.8 x 1.74 x 15 in)
<b>Weight incl. package:</b>	approx. 10.5 kg (23.15 lbs)

### Line length in LAN

The maximum line length of Cat. 5 cabling in a LAN is 100 m (328 ft) – e.g. from switch to Intercom station.

### Extent of supply

- Server
- Tool-free mountable slide rail set
- VirtuoSIS Professional licence L-SIS-x
- Short reference

### Power cable

For the S6, the power cable with country-specific plug is available separately:

- C-KAB-C13-AU (Australia)
- C-KAB-C13-EU (Europe)
- C-KAB-C13-UK (United Kingdom)
- C-KAB-C13-US (USA)

### Options

Intercom server S6 is equipped with one power supply. Install the redundant power supply improve resilience against downtimes.

- C-PA1-S6 AA: Redundant power supply  
**Note:** Appropriate power cable not included.

### Accessibility

Default IP address (br0): **10.10.0.1/16**

# Intercom Server S6

## Installation instructions

### Dimensions

Measuring units in mm (in), not to scale!

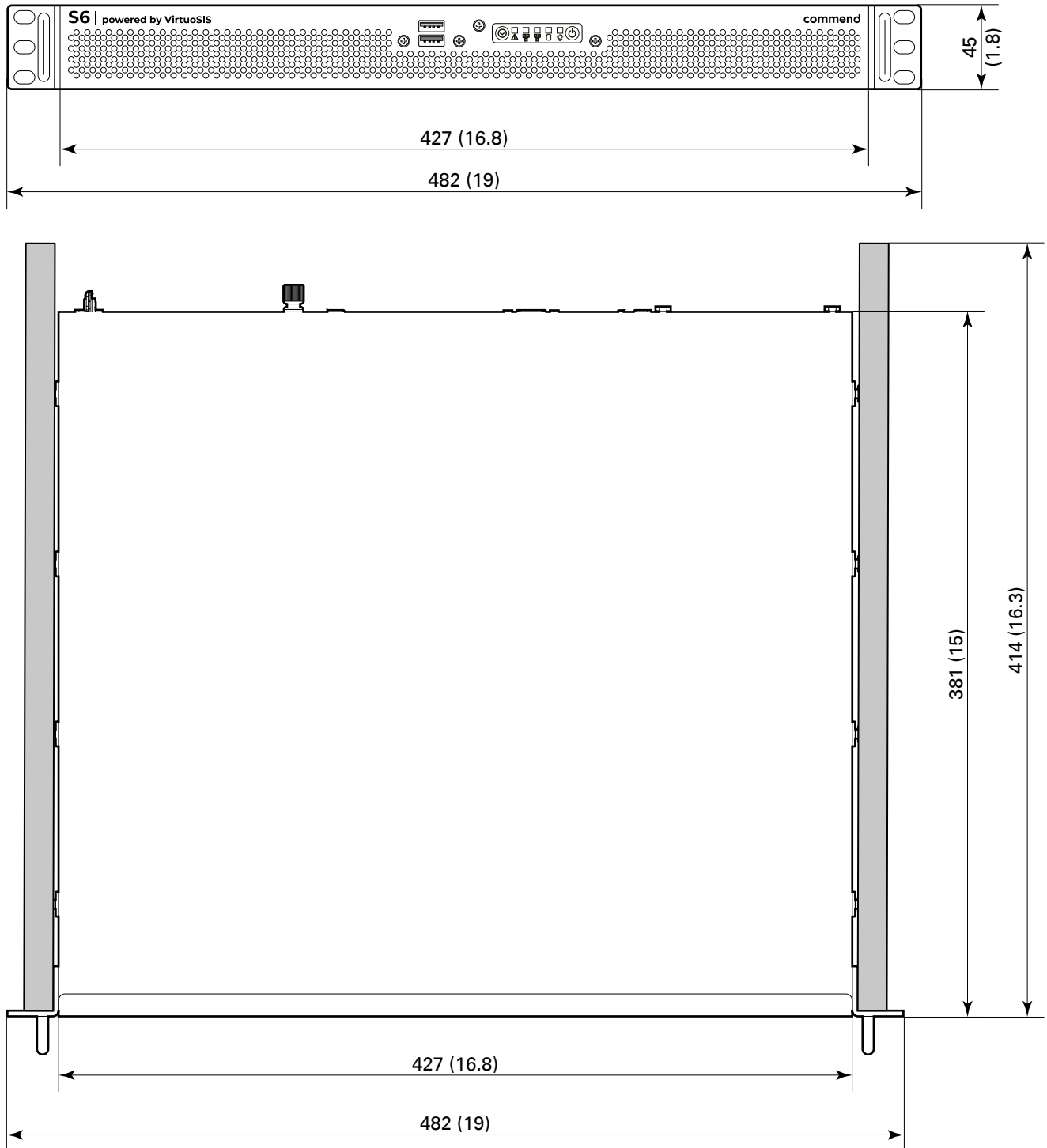

# Intercom Server S6

## Installation instructions

### Connection diagram

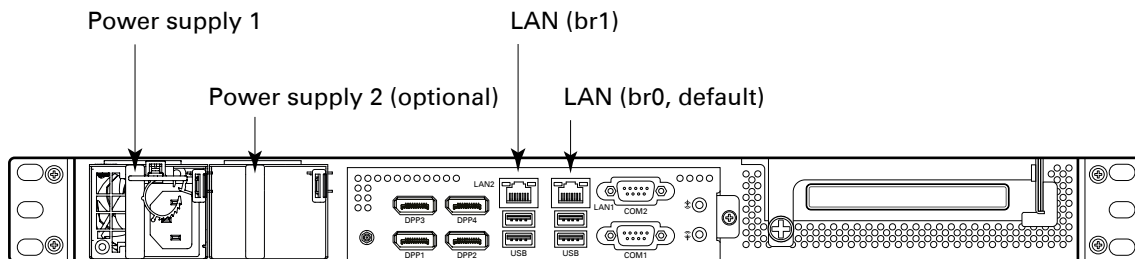

### Startup

1. Install the Intercom Server S6 in a rack
2. Power up the Intercom Server S6
3. Set up the Intercom Server S6 via VirtuobRO or PuTTY
4. Configure the Intercom Server S6 via CCT 800

- Do not extend more than one unit out of the rack simultaneously – even if the tilt protection is in place. If several units are simultaneously extended from the rack, there is a risk that the rack could tip over. For further information, see the safety information supplied with the rack.
- For ventilation clearance, at least 200 mm space has to be left from the front and rear of the server.
- Before using this device, ensure all cables are connected correctly and are not damaged.
- Allow the device to cool down completely before touching any parts.
- Install or store this device out of the reach of children and do not allow persons unfamiliar with the device and these instructions to handle and operate the device.
- All changes or modifications not expressly approved by the party responsible for compliance could void the user's authority to operate the equipment.
- All connected circuits shall fulfil the following requirements:
  - Safety Extra Low Voltage (SELV) and Limited Power Source (LPS) according to IEC/EN 60950-1 or
  - ES1, PS2 circuits and Annex Q (Limited Power Source) according to IEC/EN/UL 62368-1
- This equipment has been tested and found to comply with the limits for a Class B digital device, pursuant to part 15 of the FCC Rules. These limits are designed to provide reasonable protection against harmful interference in a residential installation. This equipment generates, uses and can radiate radio frequency energy and, if not installed and used in accordance with the instructions, may cause harmful interference to radio communications. However, there is no guarantee that interference will not occur in a particular installation. If this equipment does cause harmful interference to radio or television reception, which can be determined by turning the equipment off and on, the user is encouraged to try to correct the interference by one or more of the following measures:
  - Reorient or relocate the receiving antenna.
  - Increase the separation between the equipment and receiver.
  - Connect the equipment into an outlet on a circuit different from that to which the receiver is connected.
  - Consult the dealer or an experienced radio/TV technician for help.
-  The external DC input on the motherboard must never be powered.

### Safety warnings

- The server may only be installed by authorised service engineers.
- Do not expose the server to extreme temperatures (see data sheet).
- Observe the country-specific standards for installation, mounting and configuration.
- For installation in a rack, use the supplied rack mount kit and follow the mounting instructions in the respective short reference.
- For safety reasons and because of its weight and size, at least two persons are required to install the server in a rack.
- When connecting and disconnecting cables, observe the relevant instructions in the manual supplied with the corresponding rack.
- When installing the rack, make sure that the anti-tilt mechanism is fitted correctly.



# Intercom Server S6

## Installation instructions

Rack installation with the rack mount kit included in extent of supply

### Disassembling the rails

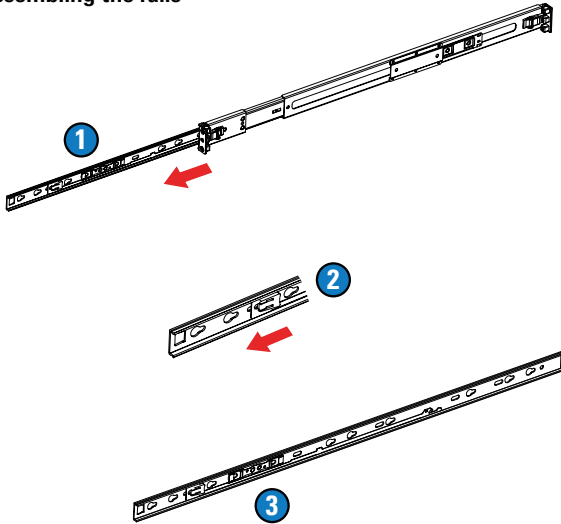

- ❶ Pull the inner rail out of the slide rail.
- ❷ Pull the white locking bars at the upfront end forward.
- ❸ Take the inner rail off the slide rail.

### Mounting the inner rails

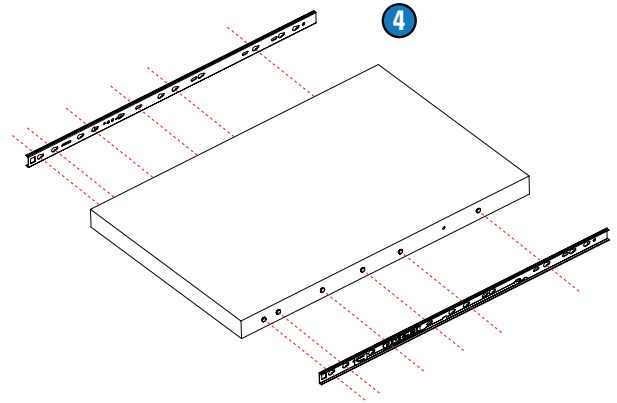

- ❹ Mount the inner rails on the server chassis.

### Mounting the inner rails

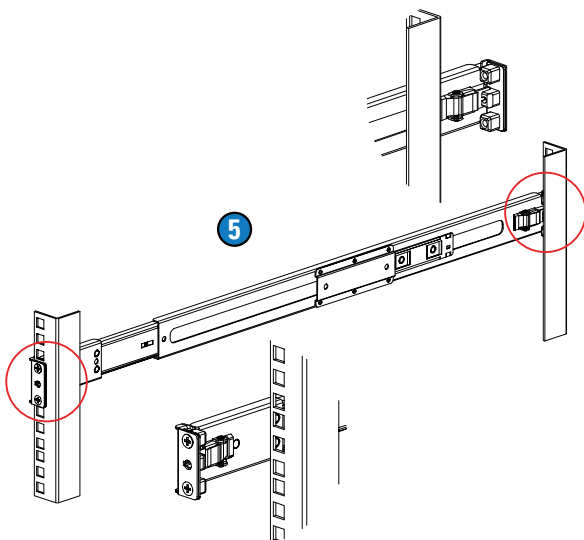

- ❺ Mount the slide rails to the frame of the rack. Attach the ends to the frame and press the bracket to fix the rail onto the frame.

### Completing the installation

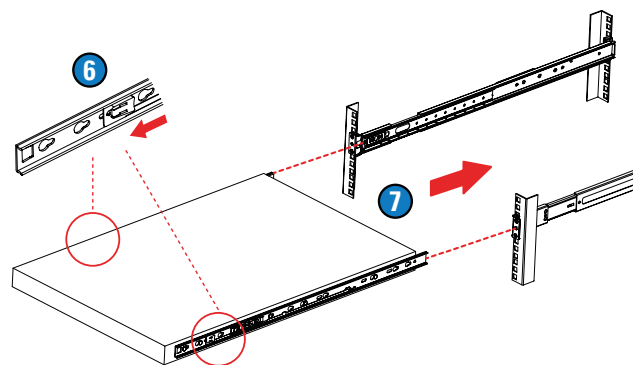

- ❻ Slide the release tabs at the outer ends back on both rails.
- ❼ Slide the fully assembled server into the rack.

# Intercom Server S6

## Complementary information

### Licensing scheme

The Intercom Server S6 provides an ideal solution for small as well as large systems. The supplied base licence VirtuoSIS Professional ("L-SIS-14") can be used for up to 448 IP/SIP subscribers and 4 VirtuoSIS Instances.

### VirtuoSIS Professional

- for up to 448 IP/SIP subscribers
- up to 4 VirtuoSIS Instances
- Slot 1 to 14 usable for subscriber and interface cards
- Slot 8 to 14 usable for networking cards
- Slot 15 reserved for networking cards (NET or LAN)

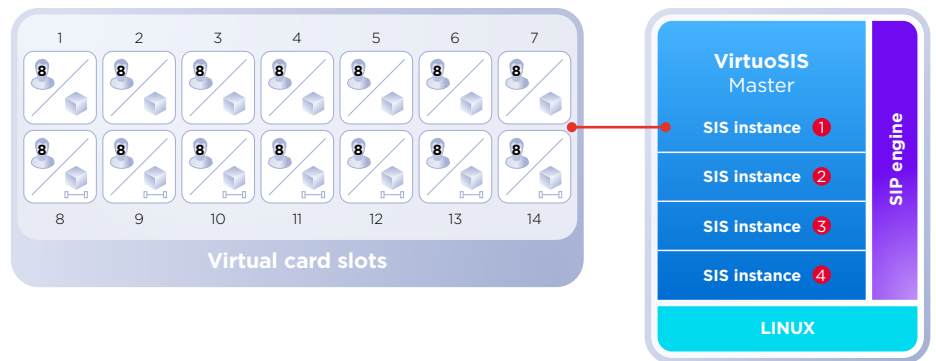

## Available licences

### Base licence

The S6 already comes with a base licence for VirtuoSIS Professional. The base licence must match the software version installed (eg. VirtuoSIS version 14 and base licence L-SIS-14). Per VirtuoSIS Master, one base licence is required.

### IP licences

L-SIS-IP-2B	Licence for 2 subscribers, feature level B
L-SIS-IP-8B	Licence for 8 subscribers, feature level B
L-SIS-IP-32B	Licence for 32 subscribers, feature level B
L-SIS-IP-2D	Licence for 2 subscribers, feature level D
L-SIS-IP-8D	Licence for 8 subscribers, feature level D

### SIP-C licences

L-SIS-SIP-8A	Licence for 8 SIP subscriber, feature level A
L-SIS-SIP-2B	Licence for 2 SIP subscribers, feature level B
L-SIS-SIP-8B	Licence for 8 SIP subscribers, feature level B
L-SIS-SIP-2D	Licence for 2 SIP subscribers, feature level D
L-SIS-SIP-8D	Licence for 8 SIP subscribers, feature level D

### Interface licence

L-SIS-ICX	Single licence for ICX interface
-----------	----------------------------------

### SIP-T licences

L-SIS-SIPT8B	Licence for SIP trunk, 8 channels, feature level B
L-SIS-SIPT1D	Licence for SIP trunk, 1 channel, feature level D
L-SIS-SIPT8D	Licence for SIP trunk, 8 channels, feature level D

### Network licences

L-SIS-LAN-4	Licence for 4 LAN connections
L-SIS-LAN-8	Licence for 8 LAN connections
L-SIS-WAN-8	Licence for 8 WAN connections
L-SYM-BRIDGE	Licence for Symphony Bridge

### Upgrade licences

L-UG-1D	Upgrade licence for 1 subscriber from feature level A, B or C to feature level D (for IoT and SIP subscribers)
L-UG-8B	Upgrade licence for 8 subscribers from feature level A to feature level B (for SIP subscribers only)

A VirtuoSIS upgrade subscription ensures that always the latest software licence for the corresponding software version can be used. This ensures that all the latest security improvements, features and problem fixes are always available.

### Further licences

In addition, various platform independent licences are available (e.g. Intercom Client, Mobile Client, Studio and ComPLC).

## Quality tested. Reliable. Smart.

COMMEND products are developed and manufactured by Commend International in Salzburg, Austria.

The development and manufacturing processes are certified in accordance with **EN ISO 9001:2015**.



The technical data contained herein has been provided solely for informational purposes and is not legally binding. Subject to change, technical or otherwise. IoT®, OpenDuplex® and Commend® are trademarks registered by Commend International GmbH. All other brands or product names are trademarks or registered trademarks of the respective owner and have not been specifically earmarked.

## A strong worldwide network

COMMEND is represented all over the world by local Commend Partners and helps to improve security and communication with tailored Intercom solutions.

[www.commend.com](http://www.commend.com)